

NL7CLX LBP/MBP Compressor R404A/R507 220-240V 50Hz

General

Code number	105F3710
Approvals	EN 60335-2-34, CCC, UL984
Compressors on pallet	80

Application

Application	LBP/MBP		
	Hz	50	60
Frequency	Hz	50	60
Evaporating temperature	°C	-45 to -5	-
Voltage range	V	198 - 254	-
Max. condensing temperature continuous (short)	°C	50 (60)	-
Max. winding temperature continuous (short)	°C	125 (135)	-

Cooling requirements

Frequency	Hz	50			60		
		LBP	MBP	HBP	LBP	MBP	HBP
32°C		F ₁	F ₁	-	-	-	-
38°C		F ₁	F ₁	-	-	-	-
43°C		F ₂	F ₂	-	-	-	-
Remarks on application:							

Motor

Motor type	RSIR/CSIR	
LRA (rated after 4 sec. UL984), HST LST	A	10.4 9.2
Cut in Current, HST LST	A	10.4 13.6
Resistance, main start winding (25°C)	Ω	8.2 14.7

Design

Displacement	cm ³	7.27
Oil quantity (type)	cm ³	320 (polyolester)
Maximum refrigerant charge	g	400
Free gas volume in compressor	cm ³	2360
Weight without electrical equipment	kg	10.5

Dimensions

Height	mm	A	203
		B	197
		B1	-
		B2	-
Suction connector	location/I.D. mm angle	C	8.2 15°
	material comment		Copper Rubber plug
Process connector	location/I.D. mm angle	D	6.2 25°
	material comment		Copper Rubber plug
Discharge connector	location/I.D. mm angle	E	6.2 35°
	material comment		Copper Rubber plug
Oil cooler connector	location/I.D. mm angle	F	-
	material comment		-
Connector tolerance	I.D. mm		±0.09
Remarks:			

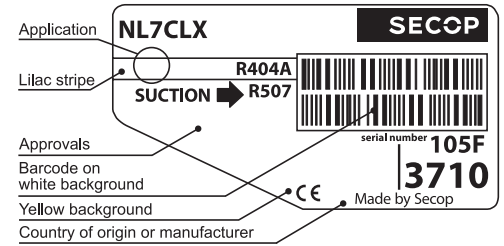

- S = Static cooling normally sufficient
- O = Oil cooling
- F₁ = Fan cooling 1.5 m/s (compressor compartment temperature equal to ambient temperature)
- F₂ = Fan cooling 3.0 m/s necessary
- SG = Suction gas cooling normally sufficient
- = not applicable in this area

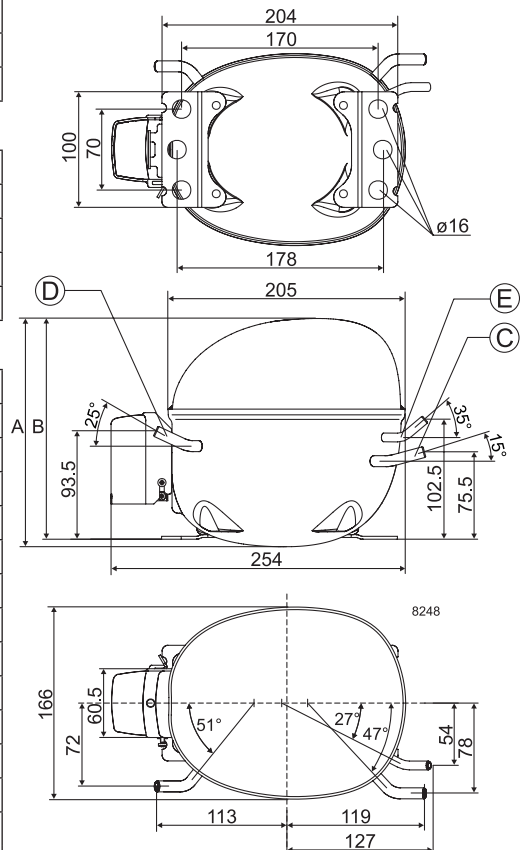

EN 12900 Household (CECOMAF) 220V, 50Hz, fan cooling F₂

Evap. temp. in °C	-45	-40	-35	-30	-25	-23.3	-20	-15	-10	-6.7	-5	0	5	7.2	10	15	20
Capacity in W	102	146	199	263	340	369	430	536	657	746	796						
Power cons. in W	158	186	214	243	274	284	306	342	381	410	426						
Current cons. in A	1.31	1.38	1.46	1.56	1.68	1.72	1.81	1.96	2.13	2.25	2.32						
COP in W/W	0.65	0.78	0.93	1.08	1.24	1.30	1.41	1.57	1.72	1.82	1.87						

ASHRAE LBP* 220V, 50Hz, fan cooling F₂

Evap. temp. in °C	-45	-40	-35	-30	-25	-23.3	-20	-15	-10	-6.7	-5	0	5	7.2	10	15	20
Capacity in W	120	171	234	309	399	433	505	628	770	875	933						
Power cons. in W	158	186	213	241	270	281	302	337	375	403	419						
Current cons. in A	1.32	1.38	1.46	1.55	1.67	1.71	1.80	1.94	2.10	2.22	2.28						
COP in W/W	0.76	0.92	1.10	1.28	1.48	1.54	1.67	1.87	2.05	2.17	2.23						

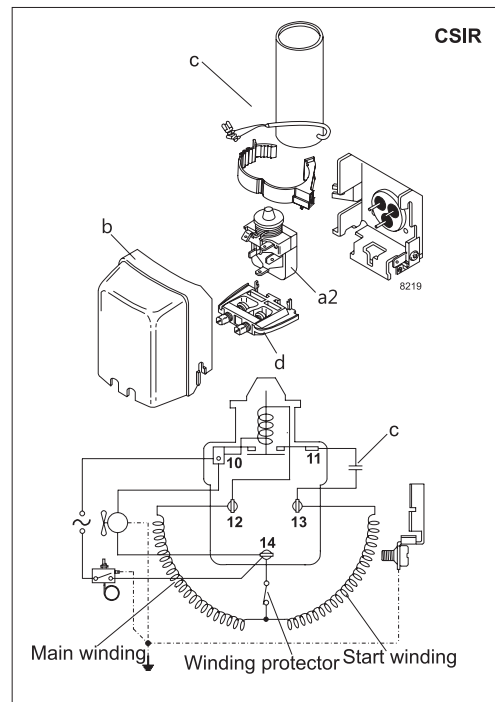
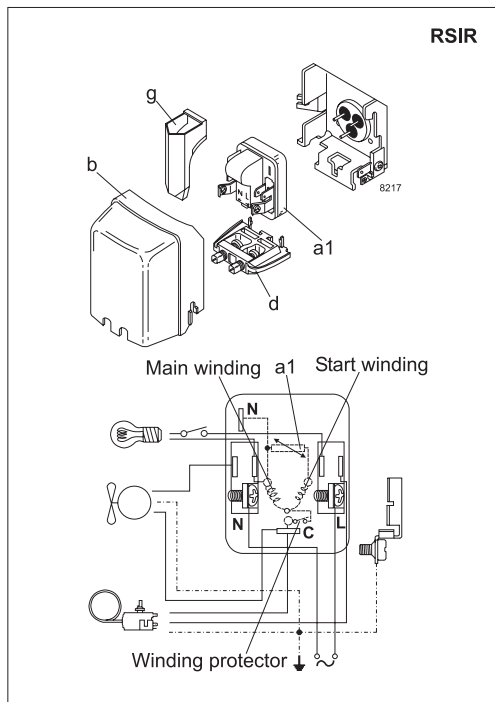

Accessories for	NL7CLX	Figure	Code number
PTC starting device	6.3 mm spade connectors	a1	103N0011
	4.8 mm spade connectors		103N0018
Starting relay	6.3 mm spade connectors	a2	117U6002
Cover		b	103N2010
Start. capacitor 80 µF	6.3 mm spade connectors	c	117U5015
Cord relief		d	103N1010
Protection screen for PTC		g	103N0476

Test conditions	EN 12900/CECOMAF	ASHRAE LBP*
Condensing temperature	45°C	43.3°C
Ambient temperature	32°C	32°C
Suction gas temperature	32°C	32°C
Liquid temperature	no subcooling	32°C

Mounting accessories		Code number
Bolt joint for one comp.	Ø: 16 mm	118-1917
Bolt joint in quantities	Ø: 16 mm	118-1918
Snap-on in quantities	Ø: 16 mm	118-1919

Nidec GA Compressors accepts no responsibility for possible errors in catalogs, brochures, and other printed material. Nidec GA Compressors reserves the right to alter its products without notice. This also applies to products already on order provided that such alterations can be made without subsequential changes being necessary to specifications already agreed. All trademarks in this material are the property of the respective companies. Secop and the Secop logotype are trademarks of Nidec Global Appliance Germany GmbH. All rights reserved. www.secop.com